

# Conesys Europe Hermetic Connectors

## AE3 Series per MIL-DTL-38999 Series III and EN3645



MIL-DTL-38999 S III



## AE3 Series Hermetic Connectors per MIL-DTL-38999 Series III and EN3645



### Features and Application

AE3 Series hermetic connector receptacles are manufactured to Conesys Europe standards and meet all the requirements of MIL-DTL-38999 Series III and EN3645.

AE3 Series are cylindrical connectors, designed for highest performance capabilities, and used in both general purpose and severe environment applications.

These connectors feature a one-turn coupling system, utilizing self-locking triple start ACME thread. ACME threads provide coupling durability, while thicker wall sections and greater coupling surface area improve strength, shock resistance and EMI shielding. Blunting of the threads on both receptacle and plug coupling nut eliminates cross threading.

Square flange, jam nut, solder, and welding receptacles are available in 9 shell sizes and insert arrangements utilizing sizes 22D, 20, 16, 12 and 8 contacts.

Customer-specific design can be proposed for special applications – Consult factory for details.

These hermetic connectors are available in stainless steel material, passivated or nickel plated. Other materials can be proposed for special applications – Please consult factory.

**MIL-STD-1560 Insert Arrangement** – AE3 Series hermetic connectors use standard insert arrangement.

**EN3645 and Specific Insert Arrangement** – AE3 Series hermetic connectors can be proposed with EN3645 or special insert arrangement – Please consult factory.

**Scoop-Proof Design** – Recessed pins in elongated shells minimize the possibility of contact damage. In a blind mating application, mating shells cannot “scoop” the pins and cause a shorting or bending of contacts.

**Interfacial Pin Insert Seal** – Raised moisture barriers around each receptacle pin, which mate into lead-in chamfers of the plug hard face socket insert, provide individual contact sealing.

**Glass insulator** – These hermetic connectors are designed with sintered compression glass as an insulator.





## Performance Specifications

### Operating Temperature Range

Classes Y and N : -65°C to +200°C (-85°F to +392°F)

### Material and Finish Data (Class)

Class Y:

RECEPTACLE	material:	stainless steel
	finish:	passivated
CONTACTS	material:	ferrous alloy
	finish:	gold plated

Class N:

RECEPTACLE	material:	stainless steel
	finish:	nickel plated
CONTACTS	material:	ferrous alloy
	finish:	gold plated

### Corrosion Resistance

Class Y: 500 hours as per MIL-DTL-38999

Class N: 48 hours as per MIL-DTL-38999

### Durability

Minimum of 500 mating cycles.

### Leakage

$< 1.10^{-7}$  atm.cm<sup>3</sup>.s<sup>-1</sup>.

### Shock and Vibration

Shock: Pulse of approximate half sine wave of 300 g ± 15% magnitude with duration of 3 ± 1 milliseconds applied in three axes. Vibration: as per MIL-DTL-38999.

### Shell-to-Shell Conductivity

Maximum potential drop shall not exceed:

Class N: 1 millivolt  
 Classes Y: 50 millivolts

### Insulation Resistance

>5000 M $\Omega$  under 500 Vdc  
 (25°C – 65% HR max.)

### Withstanding Voltage

At sea level:

Service M: 1300 V RMS

Service I: 1800 V RMS

Service II: 2300 V RMS

At 21 000 m altitude:

Service M: 800 V RMS

Service I: 1000 V RMS

Service II: 1000 V RMS

### Maximum Current Rating per Contact

Size 22D 3 Amp

Size 20 5 Amp

Size 16 10 Amp

Size 12 17 Amp

Size 8 40 Amp



**AE3 Series**  
**Hermetic Connectors**  
 per MIL-DTL-38999 Series III and EN3645



Military and Conesys Part Number Development

<b>Mil. Prefix</b>	<b>D38999/</b>	<b>21</b>	<b>Y</b>	<b>D</b>	<b>19</b>	<b>P</b>	<b>N</b>	
<b>Conesys Prefix</b>	<b>AE3</b>	<b>21</b>	<b>Y</b>	<b>D</b>	<b>19</b>	<b>P</b>	<b>N</b>	<b>-XXX</b>
<b>Shell Type (specification sheet number)</b>								
21 = Wall mount receptacle								
23 = Jam nut receptacle								
25 = Solder mount receptacle								
27 = Weld mount receptacle								
<b>Class (Material and Finish)</b>								
Y = Shell – stainless steel, passivated								
= Terminals – ferrous alloy, gold plated								
N = Shell – stainless steel, nickel plated								
= Terminals – ferrous alloy, gold plated								
<b>Shell Size</b>								
A, B, C, D, E, F, G, H, or J								
<b>Insert Arrangement</b>								
See pages 47–50								
<b>Contact Style (pin only)</b>								
P = Pin with solder cup								
X = Pin with eyelet								
C = Pin tail (for PCB)								
<b>Polarization (keying)</b>								
N = Normal								
A, B, C, D, or E for alternatives								
<b>Modification or Particularities (applies to Conesys part numbers only)</b>								
XXX = Modification								
Consult factory for details								

MIL-DTL-38999 S III



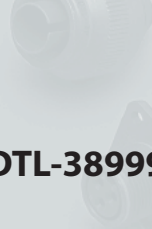

### Terminal Configuration



#### Terminal Style P

Solder cup

Available in size 22, 20, 16, 12, and 8

For other sizes, please consult factory.



#### Terminal Style X

Eyelet

Available in size 22, 20, and 16

For other sizes, please consult factory.



#### Terminal Style C

Pin tail for PCB

Available in size 22, 20, and 16

For other sizes or lengths, please consult factory.



**AE321**  
**Wall Mount Receptacle**  
**D38999/21 – EN3645Y0**



MIL-DTL-38999 S III

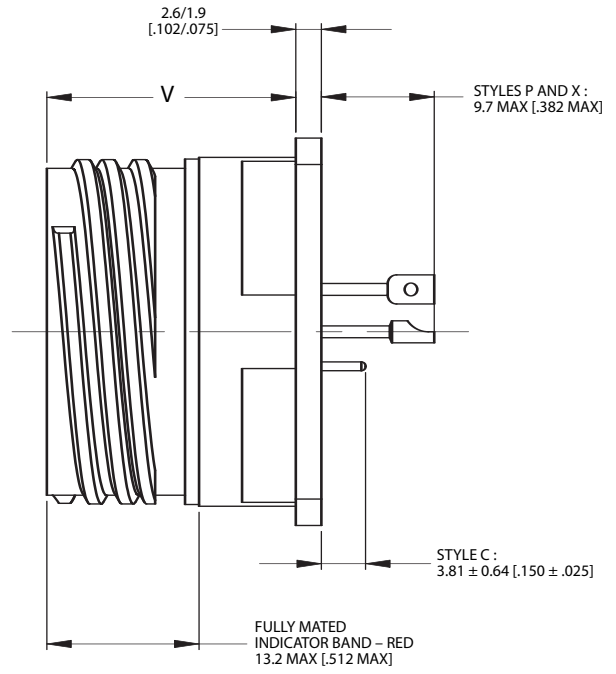
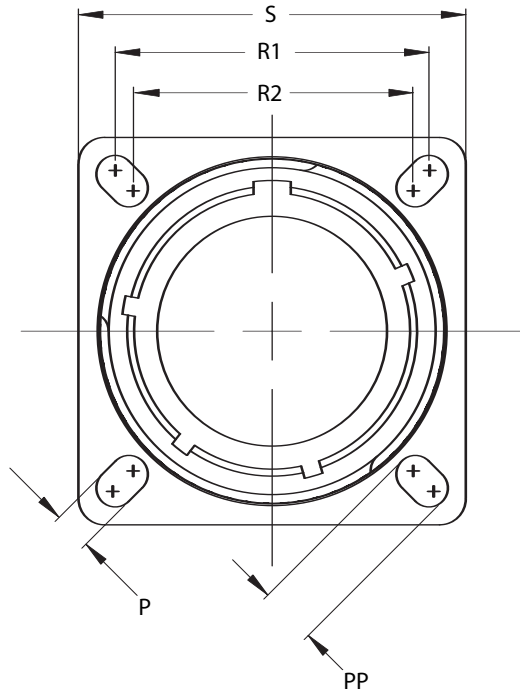

Shell Size	Shell Size Code	P		PP		R1		R2		S		V	
		$\pm 0.20$	$\pm 0.008$	$\pm 0.20$	$\pm 0.008$	(TP)		(TP)		$\pm 0.30$	$\pm 0.012$	Maximum	
		mm	inch	mm	inch	mm	inch	mm	inch	mm	inch	mm	inch
9	A	3.25	.128	5.49	.216	18.26	.719	15.09	.594	23.8	.937	21.40	.843
11	B	3.25	.128	4.93	.194	20.62	.812	18.26	.719	26.20	1.031	21.40	.843
13	C	3.25	.128	4.93	.194	23.01	.906	20.62	.812	28.60	1.126	21.40	.843
15	D	3.25	.128	4.93	.194	24.61	.969	23.01	.906	31.00	1.220	21.40	.843
17	E	3.25	.128	4.93	.194	26.97	1.062	24.61	.969	33.30	1.311	21.40	.843
19	F	3.25	.128	4.93	.194	29.36	1.156	26.97	1.062	36.50	1.437	21.40	.843
21	G	3.25	.128	4.93	.194	31.75	1.250	29.36	1.156	39.70	1.563	21.40	.843
23	H	3.91	.154	6.15	.242	34.93	1.375	31.75	1.250	42.90	1.689	21.40	.843
25	J	3.91	.154	6.15	.242	38.10	1.500	34.93	1.375	46.00	1.811	21.40	.843

Insert Arrangement and Contact Information

Insert Arrangement				Service	Total	Quantity of Contacts				
					No. of	by Size				
Series I	Series II	Series III	Series IV	Rating	Contacts	22D	20	16	12	8
9-35	8-35	A-35	—	M	6	6				
9-98	8-98	A-98	—	I	3		3			
11-2	—	B-2	B-2	I	2			2		
11-4	—	B-4	B-4	I	4		4			
11-5	10-5	B-5	B-5	I	5		5			
11-35	10-35	B-35	B-35	M	13	13				
11-98	10-98	B-98	B-98	I	6		6			
11-99	10-99	B-99	B-99	I	7		7			
13-4	12-4	C-4	C-4	I	4			4		
13-8	12-8	C-8	C-8	I	8		8			
13-35	12-35	C-35	C-35	M	22	22				
13-98	12-98	C-98	C-98	I	10		10			
15-5	14-5	D-5	D-5	II	5			5		
15-15	14-15	D-15	D-15	I	15		14	1		
15-18	14-18	D-18	D-18	I	18		18			
15-19	—	D-19	D-19	I	19		19			
15-35	14-35	D-35	D-35	M	37	37				
15-97	14-97	D-97	D-97	I	12		8	4		
17-6	16-6	E-6	E-6	I	6				6	
17-8	16-8	E-8	E-8	II	8			8		
17-26	16-26	E-26	E-26	I	26		26			
17-35	16-35	E-35	E-35	M	55	55				
17-99	16-99	E-99	E-99	I	23		21	2		

**AE1, AE2, AE3, and AE4 Series**  
**Insert Arrangement and Contact Information**  
**per MIL-STD-1560**



Insert Arrangement and Contact Information

Insert Arrangement				Service	Total	Quantity of Contacts				
					No. of	by Size				
Series I	Series II	Series III	Series IV	Rating	Contacts	22D	20	16	12	8
19-11	18-11	F-11	F-11	II	11			11		
19-28	18-28	F-28	F-28	I	28		26	2		
19-30	18-30	F-30	F-30	I	30		29	1		
19-32	18-32	F-32	F-32	I	32		32			
19-35	18-35	F-35	F-35	M	66	66				
21-11	—	G-11	G-11	I	11				11	
21-16	20-16	G-16	G-16	II	16			16		
21-35	20-35	G-35	G-35	M	79	79				
21-39	20-39	G-39	G-39	I	39		37	2		
21-41	20-41	G-41	G-41	I	41		41			
21-48 *	—	G-48 *	G-48 *	I	4					4
23-21	22-21	H-21	H-21	II	21			21		
23-32	22-32	H-32	H-32	I	32		32			
23-35	22-35	H-35	H-35	M	100	100				
23-53	22-53	H-53	H-53	I	53		53			
23-55	22-55	H-55	H-55	I	55		55			
25-4	24-4	J-4	J-4	I	56		48	8		
25-19	24-19	J-19	J-19	I	19				19	
25-24	24-24	J-24	J-24	I	24			12	12	
25-29	24-29	J-29	J-29	I	29			29		
25-35	24-35	J-35	J-35	M	128	128				
25-43	—	J-43	J-43	I	43		23	20		
25-61	24-61	J-61	J-61	I	61		61			

\* Not MIL-STD-1560 layout





Insert Arrangement Views



9-35/8-35  
A35,  
6 # 22D, M



9-98/8-98  
A98,  
3 # 20, I

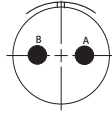

11-2  
B2,  
2 # 16, I

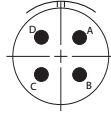

11-4  
B4,  
4 # 20, I

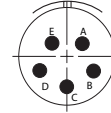

11-5/10-5  
B5,  
5 # 20, I

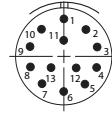

11-35/10-35  
B35,  
13 # 22D, M

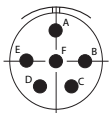

11-98/10-98  
B98,  
6 # 20, I

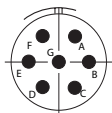

11-99/10-99  
B99,  
7 # 20, I

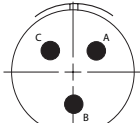

12-3  
3 # 16, II

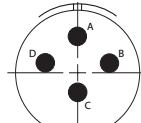

13-4/12-4  
C4,  
4 # 16, I

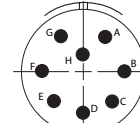

13-8/12-8  
C8,  
8 # 20, I



13-35/12-35  
C35,  
22 # 22D, M

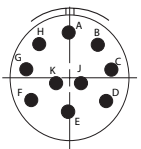

13-98/12-98  
C98,  
10 # 20, I

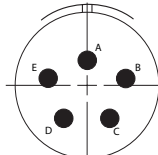

15-5/14-5  
D5,  
5 # 16, II

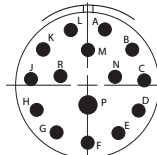

15-15/14-15  
D15,  
1 # 16, 14 # 20, I

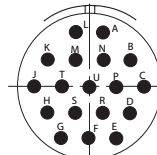

15-18/14-18  
D18,  
18 # 20, I

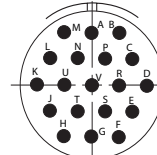

15-19  
D19,  
19 # 20, I

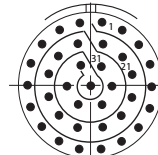

15-35/14-35  
D35,  
37 # 22D, M

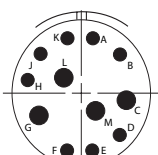

15-97/14-97  
D97,  
4 # 16, 8 # 20, I

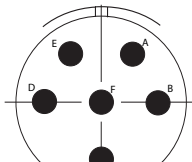

17-6/16-6  
E6,  
6 # 12, I

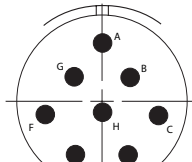

17-8/16-8  
E8,  
8 # 16, II

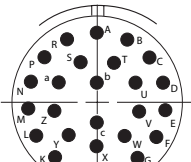

17-26/16-26  
E26,  
26 # 20, I

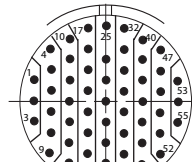

17-35/16-35  
E35,  
55 # 22D, M

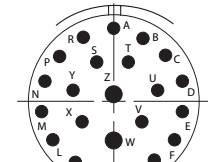

17-99/16-99  
E99,  
2 # 16, 21 # 20, I

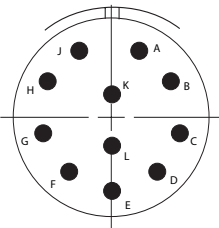

19-11/18-11  
F11,  
11 # 16, II

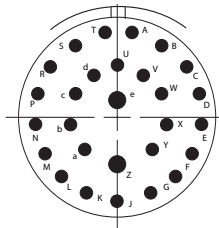

19-28/18-28  
F28,  
2 # 16, 26 # 20, I

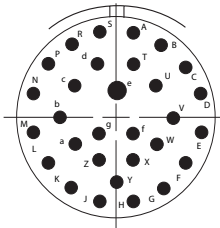

19-30/18-30  
F30,  
1 # 16, 29 # 20, I

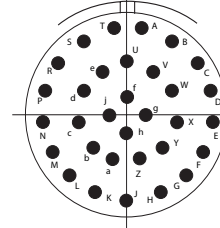

19-32/18-32  
F32,  
32 # 20, I

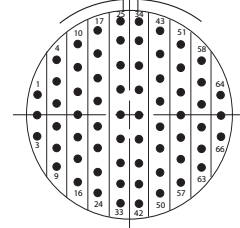

19-35/18-35  
F35,  
66 # 22D, M

**AE1, AE2, AE3, and AE4 Series**  
**Insert Arrangement (Pin Front View)**  
 per MIL-STD-1560



Insert Arrangement Views

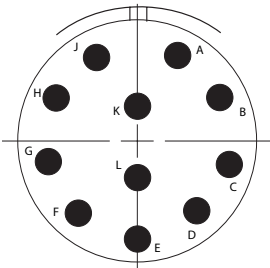

21-11  
G11,  
11 # 12, I

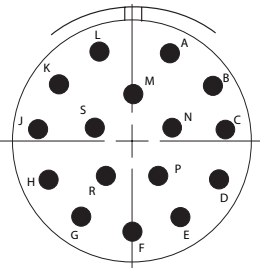

21-16/20-16  
G16,  
16 # 16, II

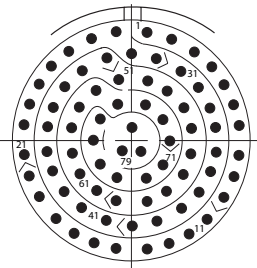

21-35/20-35  
G35,  
79 # 22D, M

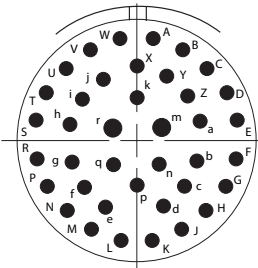

21-39/20-39  
G39,  
2 # 16, 37 # 20, I

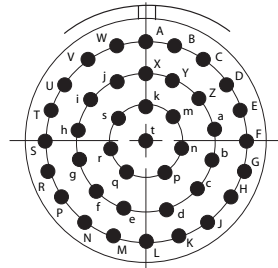

21-41/20-41  
G41,  
41 # 20, I

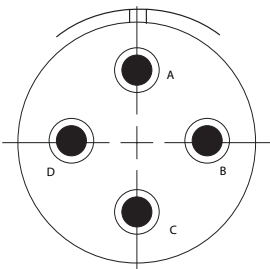

21-48\*  
G48\*,  
4 # 8 Power, I

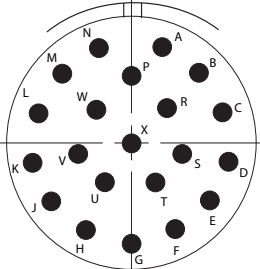

23-21/22-21  
H21,  
21 # 16, II

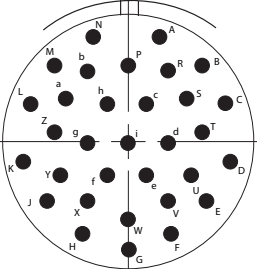

23-32/22-32  
H32,  
32 # 20, I

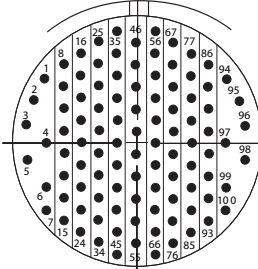

23-35/22-35  
H35,  
100 # 22D, M

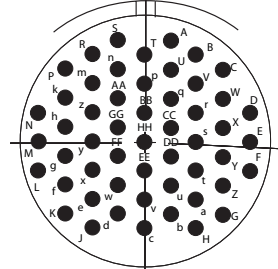

23-53/22-53  
H53,  
53 # 20, I

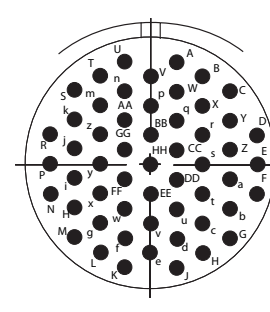

23-55/22-55  
H55,  
55 # 20, I

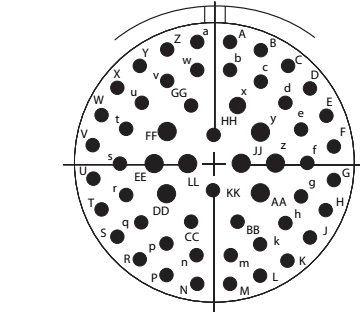

25-4/24-4  
J4,  
8 # 16, 48 # 20, I

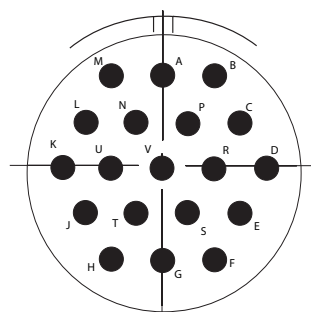

25-19/24-19  
J19,  
19 # 12, I

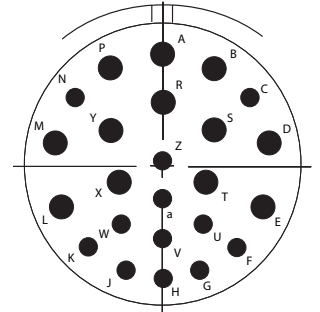

25-24/24-24  
J24,  
12 # 12, 12 # 16, I

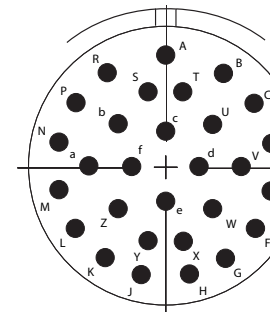

25-29/24-29  
J29,  
29 # 16, I

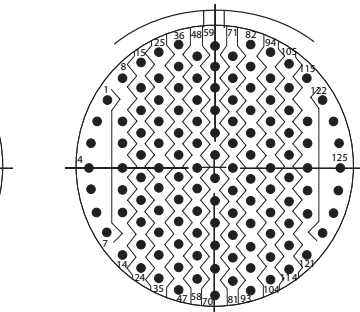

25-35/24-35  
J35,  
128 # 22D, M

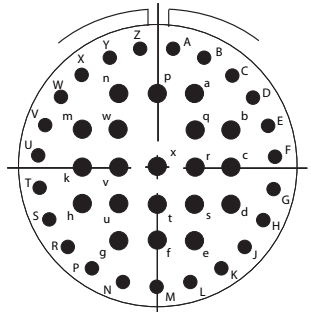

25-43  
J43,  
20 # 16, 23 # 20, I

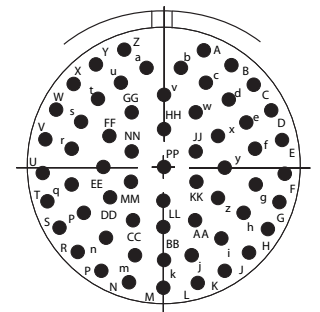

25-61/24-61  
J61,  
61 # 20, I

\* Not MIL-STD-1560 layout